

MAXIMUM SOLUTIONS

Mill-Max Introduces .050" (1,27 mm) Pitch Solder Cup Headers & Sockets

For applications that demand a highly reliable interconnect in a compact format

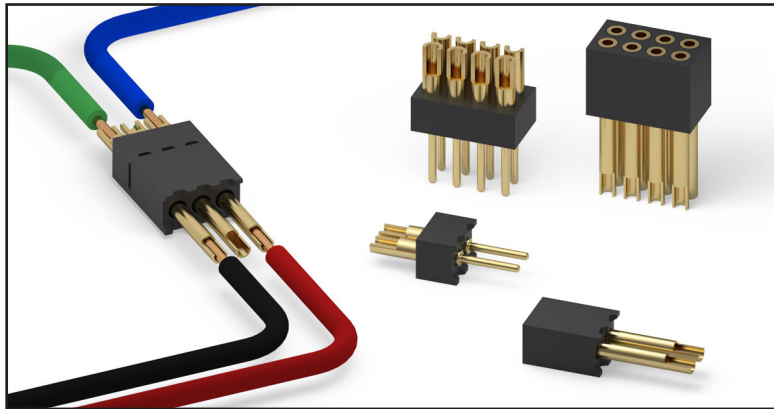

Mill-Max Mfg., Corp., North America's largest manufacturer of Precision Machined interconnects is proud to present new, .050" (1,27 mm) pitch solder cup headers and sockets for termination of fine gauge wires and cables. These solder cup connectors are ideal for applications that demand a highly reliable interconnect in a compact format.

Our high quality, .050" (1,27 mm) pitch solder cup interconnects are the choice for terminating cables and wires used in critical applications such as medical and industrial equipment. The headers and sockets each feature closed cavity pins and receptacles providing isolation between the soldering and interconnect areas; keeping solder from contaminating the pin and socket connection. The soldercups are uniformly aligned to facilitate efficient soldering, especially useful for terminating cables, and can accept up to 26 AWG stranded wire.

The male headers have .016" (0,41 mm) diameter tails suitable for mating with all Mill-Max .050" (1,27 mm) pitch SMT and through hole board mount sockets, perfect for making wire to board connections. The female socket features receptacles with Mill-Max's signature two-piece construction of a precision-machined shell and stamped beryllium copper internal contact designed for repeated mating while maintaining reliable contact over the life of the product.

The insulator material for both the header and mating socket is high performance Nylon 46 with excellent chemical resistance, mechanical strength and an HDT of 290° C to withstand most soldering processes. The standard plating option is gold, providing interconnect reliability, corrosion protection and wear resistance.

Connectors are available in single and double row configurations:

Single row 1-50 positions: [850-10-OXX-10-003000](#) (Header) & [851-13-OXX-10-003000](#) (Socket)

Double row 2 -100 positions: [852-10-XXX-10-00300](#) (Header) & [853-13-XXX-10-00300](#) (Socket)

For more information, please visit www.mill-max.com/PR684.

About Mill-Max

Mill-Max is the leading US manufacturer of machined interconnect components with a vertically integrated manufacturing facility headquartered at 190 Pine Hollow Rd., Oyster Bay, NY 11771. Its full product line includes spring-loaded connectors, SIP, DIP, PGA and BGA sockets, board-to-board interconnects and pin headers, surface mount and custom products, PCB pins and receptacles, solder terminals, wrapost receptacles and terminals. The company's complete manufacturing facility includes engineering, tooling, primary and secondary machining, stamping, plating, injection molding, and assembly.



INTERCONNECTS

SERIES 850, 851, 852, 853 • .050" GRID SOLDER CUP HEADERS AND SOCKETS • SINGLE AND DOUBLE ROW STRIPS

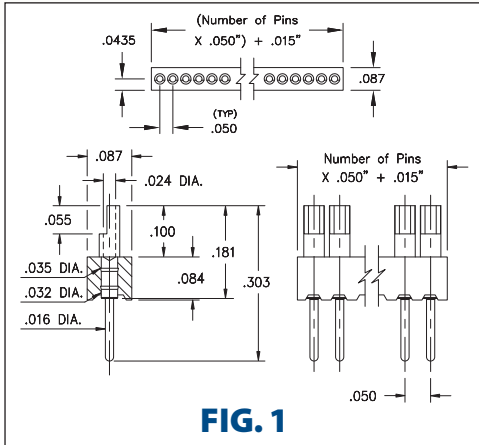

FIG. 1

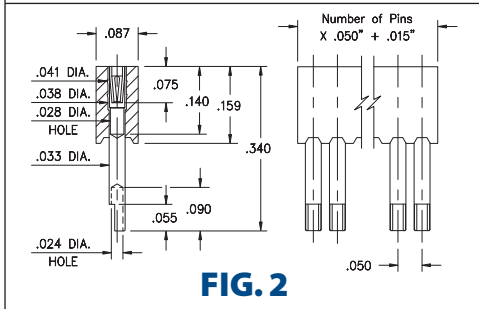

FIG. 2

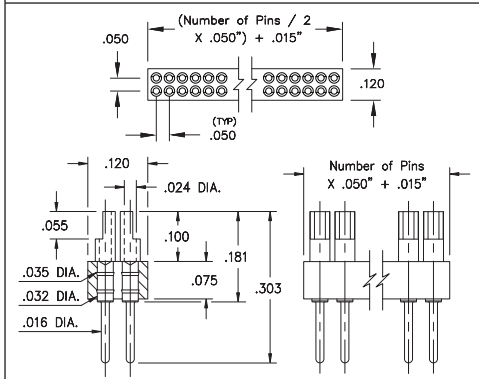

FIG. 3

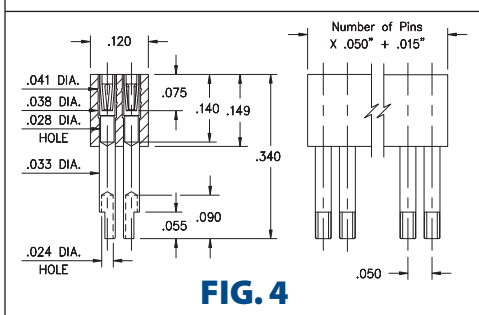
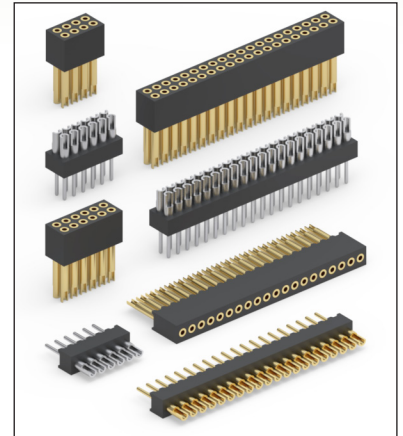

FIG. 4

- Solder cups are pre-aligned and accept up to 26 AWG wire
- Series 850 and 852 headers use MM #3050-0 pins. See page 244 for details
- Series 851 and 853 sockets use MM #1157-0 receptacles that accept pin diameters from .015"-.020". See page 160 for details
- Receptacles use Hi-Rel, 3-finger BeCu #11 contact rated at 3 amps. See page 251 for details
- Insulators are high temperature thermoplastic, suitable for all soldering operations



ORDERING INFORMATION











FIG. 1	Series 850...003	Single Row Solder Cup / Solder Tail				
	850-XX-0	-10-003000	Specify number of pins	01-50		
FIG. 2	Series 851...003	Single Row Solder Cup Sockets				
	851-XX-	-10-003000	Specify number of pins	01-50		
  						
SPECIFY PLATING CODE XX=		10 				
Pin Plating 		10 μ" Au				

FIG. 3	Series 852...003	Double Row Solder Cup / Solder Tail				
	852-XX-0	-10-003000	Specify number of pins	002-100		
FIG. 4	Series 853...003	Double Row Solder Cup Sockets				
	853-XX-	-10-003000	Specify number of pins	002-100		
  						
SPECIFY PLATING CODE XX=		13 				
Sleeve (Pin) 		10 μ" Au				
Contact (Clip) 		30 μ" Au				

