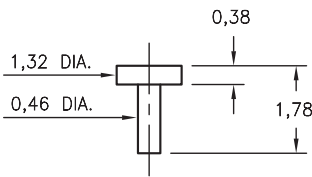
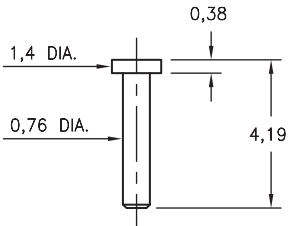
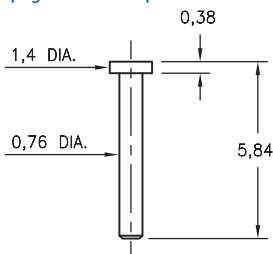
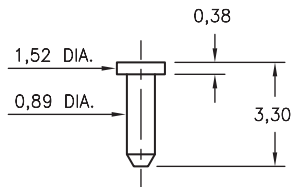
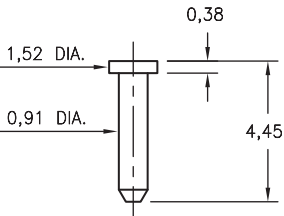
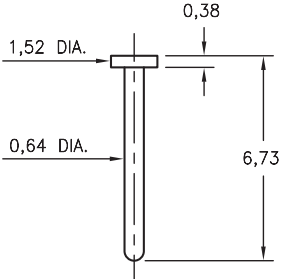
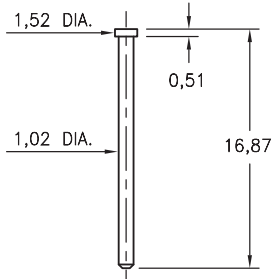
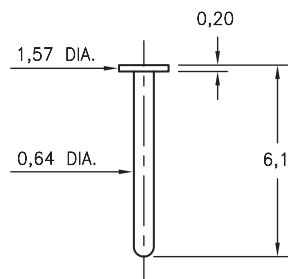
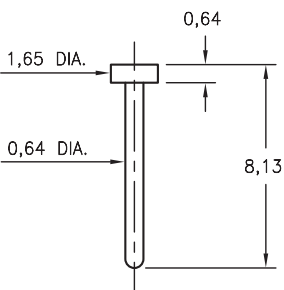
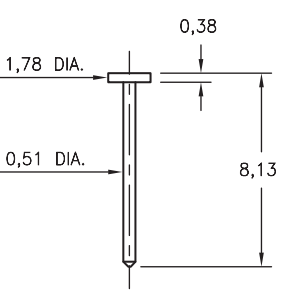
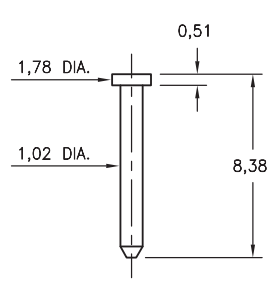
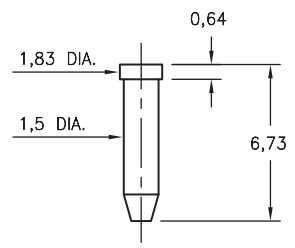

MALE PCB PINS

PRINTED CIRCUIT PINS • NAIL HEAD TYPE

<p>4361 4361-0-00-XX-00-00-33-0 Solder mount in 0,56 mounting hole Also available on 16mm wide carrier tape: 3,600 parts per 330mm reel. See page 224.2 for Tape & Reel details</p> 	<p>6477 6477-0-00-XX-00-00-38-0 Solder mount in 0,86 mounting hole</p> 	<p>4477 4477-0-00-XX-00-00-33-0 Solder mount in 0,86 mounting hole Also available on 24mm wide carrier tape: 1,300 parts per 330mm reel. See page 224.2 for Tape & Reel details</p> 	<p>4268 4268-0-00-XX-00-00-33-0 Solder mount in 0,99 mounting hole</p> 
<p>9086 9086-0-00-XX-00-00-33-0 Solder mount in 1,02 mounting hole</p> 	<p>5850 5850-0-00-XX-00-00-03-0 Solder mount in 0,74 mounting hole</p> 	<p>1179 1179-0-00-XX-00-00-33-0 Solder mount in 1,12 mounting hole</p> 	<p>5240 5240-0-00-XX-00-00-33-0 Solder mount in 0,74 mounting hole</p> 
<p>6170 6170-0-00-XX-00-00-03-0 Solder mount in 0,74 mounting hole</p> 	<p>8808 8808-0-00-XX-00-00-33-0 Solder mount in 0,61 mounting hole</p> 	<p>8330 8330-0-00-XX-00-00-38-0 Solder mount in 1,12 mounting hole</p> 	<p>9265 9265-0-00-XX-00-00-38-0 Solder mount in 1,6 mounting hole Also available on 16mm wide carrier tape: 1,170 parts per 330mm reel. See page 224.2 for Tape & Reel details</p> 

SPECIFICATIONS:

Pin Material: Brass Alloy 360, 1/2 Hard
(Except where noted)

Dimensions: Millimeters

Tolerances On: Lengths: $\pm 0,13$
Diameters: $\pm 0,051$
Angles: $\pm 2^\circ$



ORDER CODE: XXXX - X - 00 - XX - 00 - 00 - XX - 0

BASIC PART # →

SPECIFY PIN FINISH:

- 01 5,08μm TIN/LEAD OVER NICKEL
- ◆ 80 5,08μm TIN OVER NICKEL (RoHS)
- ◆ 15 0,25μm GOLD OVER NICKEL (RoHS)
- ◆ 21 0,51μm GOLD OVER NICKEL (RoHS)
- ◆ 34 1,27μm GOLD OVER NICKEL (RoHS)

