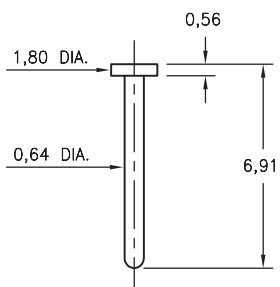
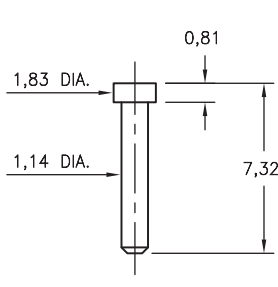
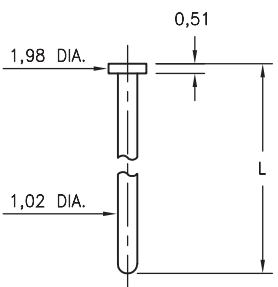
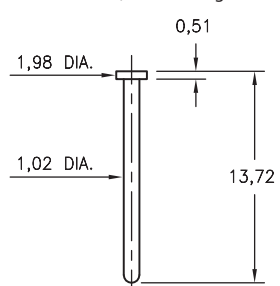
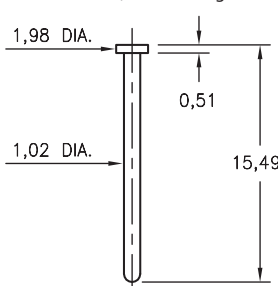
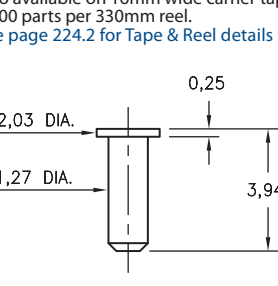
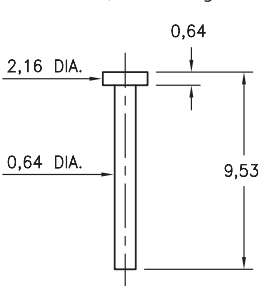
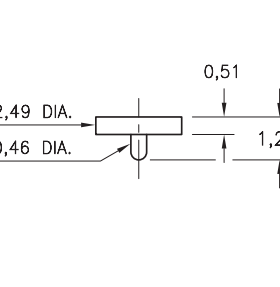
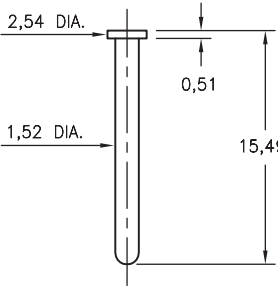
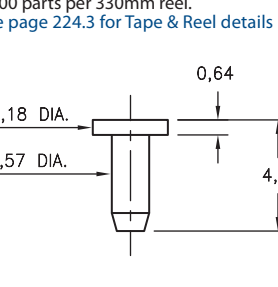

# MALE PCB PINS

## PRINTED CIRCUIT PINS • NAIL HEAD TYPE

<p><b>2650</b> 2650-0-00-XX-00-00-33-0 Solder mount in 0,74 mounting hole</p> 	<p><b>9872</b> 9872-0-00-XX-00-00-33-0 Solder mount in 1,24 mounting hole</p> 	<p><b>6095</b> 6095-X-00-XX-00-00-38-0 Solder mount in 1,12 mounting hole</p> 	<table border="1"> <thead> <tr> <th>Basic Part Number</th> <th>Length L</th> </tr> </thead> <tbody> <tr> <td>6095-0</td> <td>14,73</td> </tr> <tr> <td>6095-1</td> <td>12,07</td> </tr> </tbody> </table>	Basic Part Number	Length L	6095-0	14,73	6095-1	12,07
Basic Part Number	Length L								
6095-0	14,73								
6095-1	12,07								
<p><b>9228</b> 9228-0-00-XX-00-00-38-0 Solder mount in 1,12 mounting hole</p> 	<p><b>6092</b> 6092-0-00-XX-00-00-33-0 Solder mount in 1,12 mounting hole</p> 	<p><b>2381</b> 2381-0-00-XX-00-00-33-0 Solder mount in 1,37 mounting hole Also available on 16mm wide carrier tape: 1,800 parts per 330mm reel. See page 224.2 for Tape &amp; Reel details</p> 	<p><b>5062</b> 5062-0-00-XX-00-00-33-0 Solder mount in 0,74 mounting hole</p> 						
<p><b>4541</b> 4541-0-00-XX-00-00-03-0 Solder mount in 0,56 mounting hole</p> 	<p><b>6142</b> 6142-0-00-XX-00-00-33-0 Solder mount in 1,63 mounting hole</p> 	<p><b>9022</b> 9022-0-00-XX-00-00-33-0 Solder mount in 1,68 mounting hole Also available on 24mm wide carrier tape: 1,500 parts per 330mm reel. See page 224.3 for Tape &amp; Reel details</p> 							

### SPECIFICATIONS:

**Pin Material:** Brass Alloy 360, 1/2 Hard  
(Except where noted)

**Dimensions:** Millimeters

**Tolerances On:** Lengths:  $\pm 0,13$   
Diameters:  $\pm 0,051$   
Angles:  $\pm 2^\circ$



ORDER CODE: XXXX - 0 - 00 - XX - 00 - 00 - XX - 0

BASIC PART #

SPECIFY PIN FINISH:

- 01 5,08 $\mu$ m TIN/LEAD OVER NICKEL
- ◆ 80 5,08 $\mu$ m TIN OVER NICKEL (RoHS)
- ◆ 15 0,25 $\mu$ m GOLD OVER NICKEL (RoHS)
- ◆ 21 0,51 $\mu$ m GOLD OVER NICKEL (RoHS)
- ◆ 34 1,27 $\mu$ m GOLD OVER NICKEL (RoHS)

