

MALE PCB PINS

PRINTED CIRCUIT PINS

5231

5231-0-00-XX-00-00-38-0

Swage mount in 2,39 hole
For a 3,18 thick board

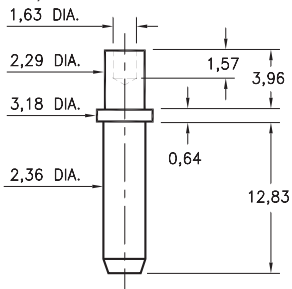

9092

9092-0-00-XX-00-00-38-0

Wire crimp termination up to 14 AWG

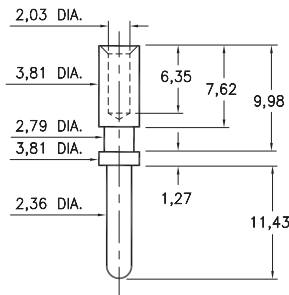

7310

7310-0-01-XX-00-00-08-0

Board edge press-fit

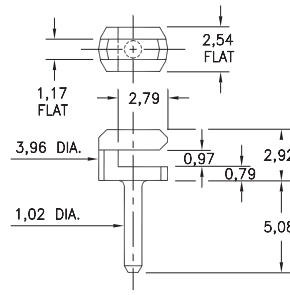

5066

5066-0-00-26-00-00-03-0

Press-fit in 1,09 mounting hole

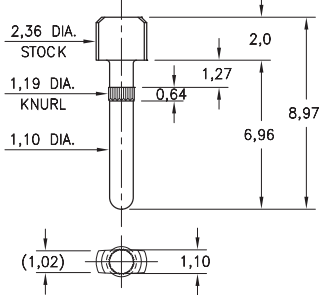

7937

7937-0-00-15-00-00-03-0

Target contact, horizontal surface mount
Also available on 16mm wide carrier tape:
2,400 parts per 330mm reel.
See page 224.4 for Tape & Reel details

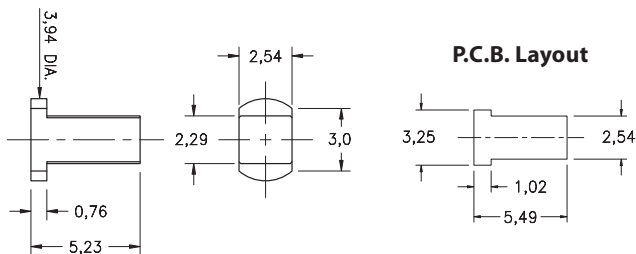

1502

1502-0-00-XX-00-00-03-0

Press-fit in 1,45 mounting hole

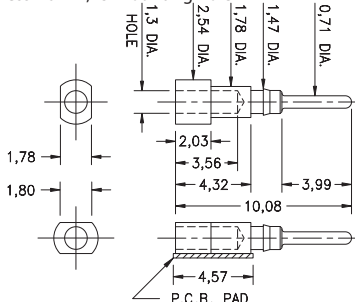

P.C.B. Layout

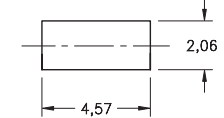

5102

5102-0-00-XX-00-00-33-0

Press-fit in 1,45 mounting hole

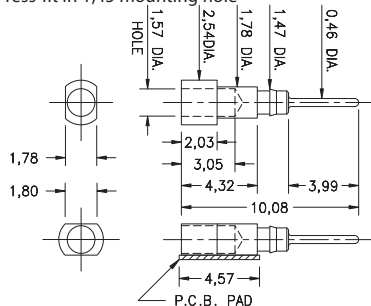

P.C.B. Layout

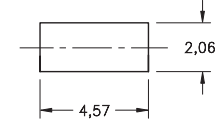

1508

1508-0-00-15-00-00-03-0

Test point, surface mount
Also available on 16mm wide carrier tape:
1,600 parts per 330mm reel.
See page 224.3 for Tape & Reel details

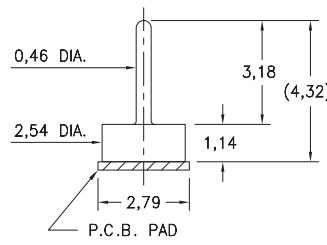

P.C.B. Layout

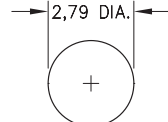

SPECIFICATIONS:

Pin Material: Brass Alloy 360, 1/2 Hard
(Except swage pins which are annealed)

Dimensions: Millimeters

Tolerances On: Lengths: $\pm 0,13$
Diameters: $\pm 0,051$
Angles: $\pm 2^\circ$



ORDER CODE: **XXXX - X - 0X - XX - 00 - 00 - XX - 0**

BASIC PART #

SPECIFY PIN FINISH:

- 01 5,08 μ m TIN/LEAD OVER NICKEL
- ◆ 80 5,08 μ m TIN OVER NICKEL (RoHS)
- ◆ 15 0,25 μ m GOLD OVER NICKEL (RoHS)
- ◆ 21 0,51 μ m GOLD OVER NICKEL (RoHS)
- ◆ 34 1,27 μ m GOLD OVER NICKEL (RoHS)

